

# Φ5MM YELLOW ROUND LED

## A-503S4Y31C-2.6

### Features

- Round type
- Yellow emitting color
- Low current operation
- Lead free, RoHS compliant

### Applications

- Indicator
- TV set
- Auto
- Monitor

### Ordering Information

Part Number	Emission Color	Lens Color	Bin Code	Luminous Intensity IV (mcd) (IF=20mA)		
				Min.	Typ.	Max.
A-503S4Y31C-2.6	Yellow	Water Clear	G	2501	3001	3500
			H	3501	4113	4725
			K	4726	5435	6144

**Maximum Ratings**

Parameter	Symbol	Value	Unit
Operating temperature	T <sub>OP</sub>	-35 ~ 85	°C
Storage temperature	T <sub>STG</sub>	-35 ~ 85	°C
Forward current (T <sub>A</sub> =25 °C)	I <sub>F</sub>	30	mA per seg
Peak forward current (T <sub>A</sub> =25 °C) * <sup>1</sup>	I <sub>PF</sub>	120	mA per seg
Reverse voltage (T <sub>A</sub> =25 °C)	V <sub>R</sub>	5	V per seg
Power consumption (T <sub>A</sub> =25 °C)	P	80	mW per seg

\*1 at 1/10 Duty Cycle

**Electrical / Optical Characteristics (1)**(T<sub>A</sub> = 25 °C)

Parameter		Symbol	Value	Unit
<b>Wavelength at peak emission</b>	(Typ.)	λ <sub>P</sub>	590	nm
<b>Dominant wavelength</b> IF = 20mA	(Typ.)	λ <sub>D</sub>	-	nm
<b>Spectral bandwidth at 50%</b> IF = 20mA	(Typ.)	Δλ	20	nm
<b>Viewing angle at 50%</b> IF = 20mA	(Typ.)	2θ <sub>1/2</sub>	23	degree
<b>Forward voltage</b> IF = 20mA	(Min.)	V <sub>F</sub>	1.8	V
	(Typ.)	V <sub>F</sub>	2.1	V
	(Max.)	V <sub>F</sub>	2.4	V
<b>Reverse current</b> VR = 5V	(Max.)	I <sub>R</sub>	10	μA
<b>Optical efficiency</b> IF = 20mA	(Typ.)	η <sub>OPT</sub>	-	lm/W

**Luminous Intensity Bin Groups**(T<sub>A</sub> = 25 °C & I<sub>F</sub> = 20 mA)

Bin Code	Luminous Intensity I <sub>v</sub> (mcd)		
	Min.	Typ.	Max.
G	2501	3001	3500
H	3501	4113	4725
K	4726	5435	6144

Electrical/Optical Charateristic (2)

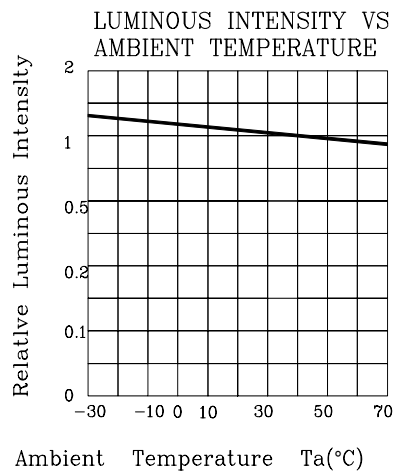
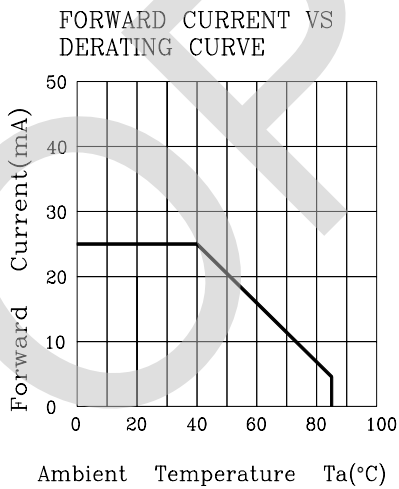
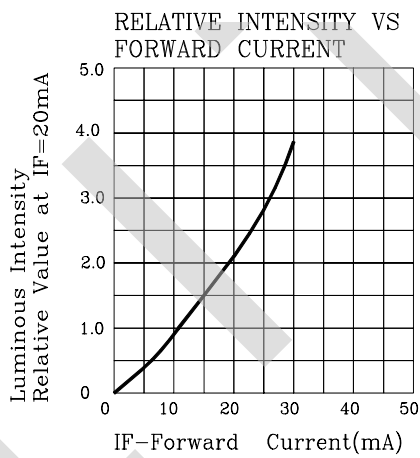
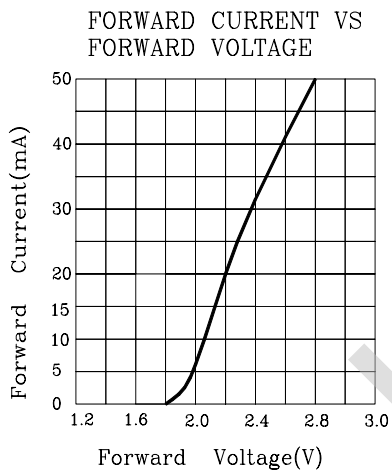
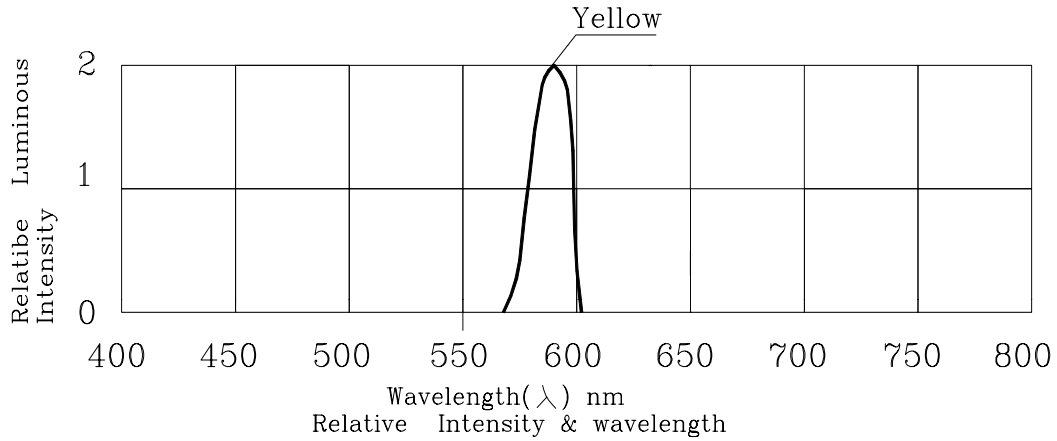

Package Outline Dimensions

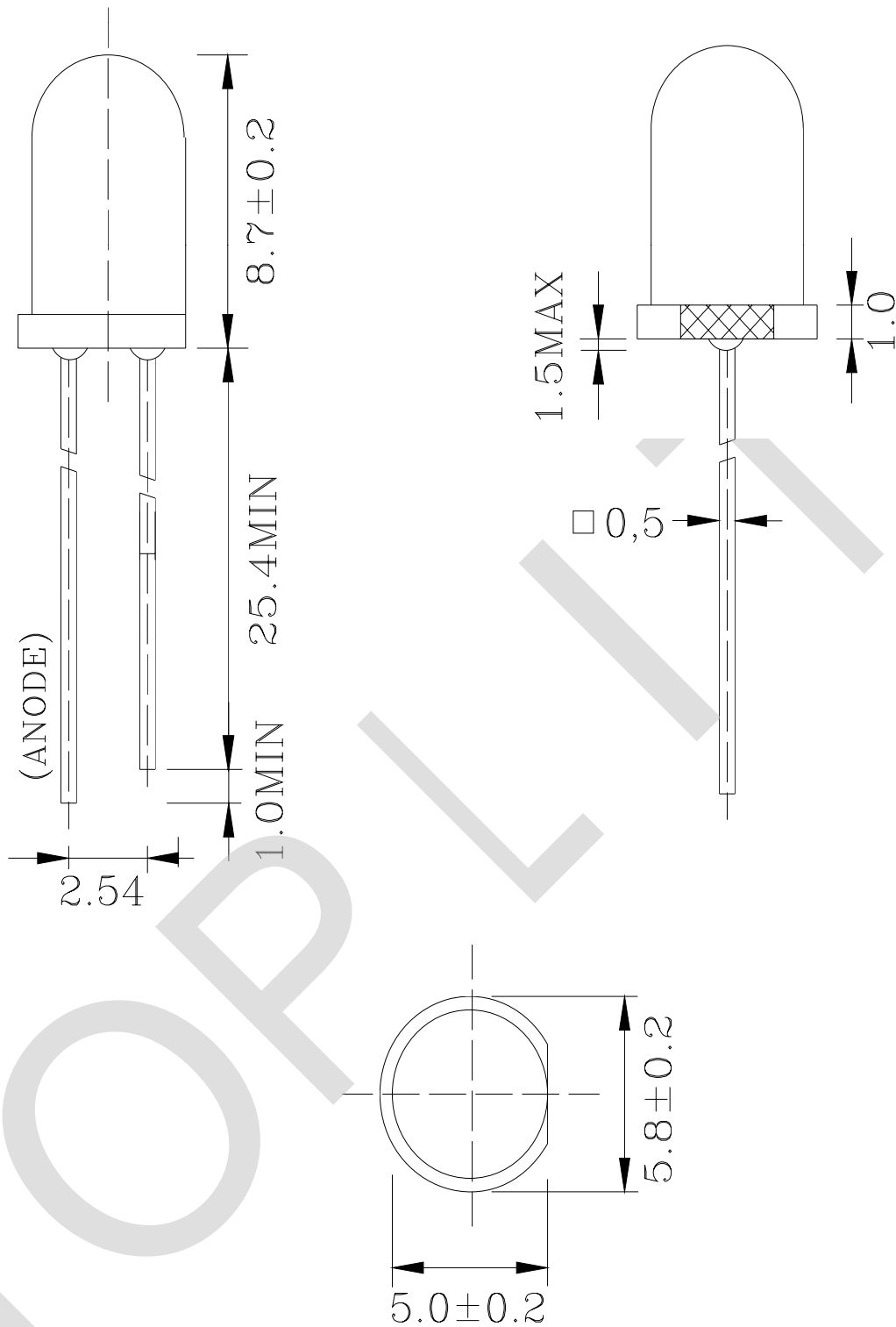

Notes:

1. All dimensions are in millimeters. Tolerance is  $\pm 0.25$  unless otherwise noted.
2. The specifications, characteristics and technical data described in the datasheet are subject to change without prior notice.

## Display Soldering Conditions

The recommended conditions for soldering are as follows. Because the component is made with epoxy resin, the units are susceptible to heat. Therefore, the preheating and soldering temperatures should be kept as low as possible to avoid damage.

### 1 . Manual Soldering Conditions(with 1.5mm Iron tip )

Iron Tip Temperature: 350°C Max, Time: 3s Max

Position: The iron should be situated at least 2mm away from the root of the leads.

### 2 . Through the Wave Soldering Conditions

Wave Soldering Profile For Lead-free Through-hole LED

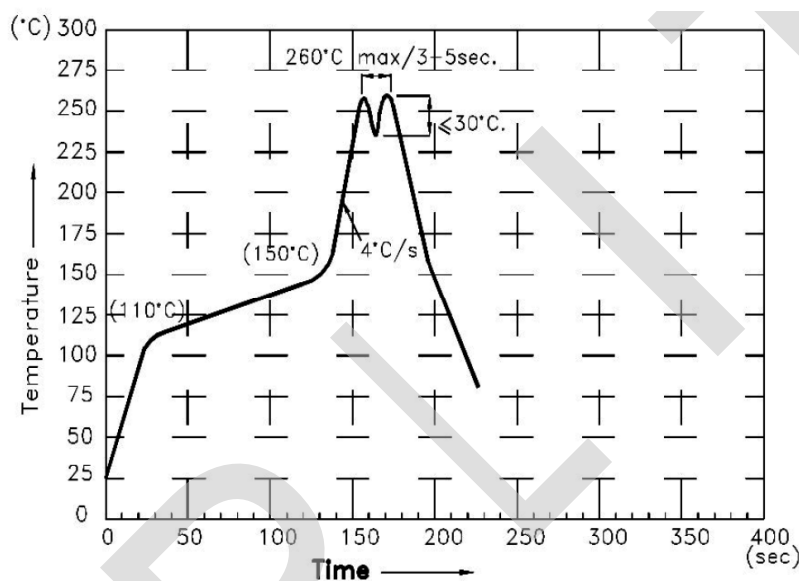

### 3 . Soldering General Notes:

- TOPLITE recommend manual soldering to be used only for repair and rework purposes. The soldering iron should not exceed 30W in power. The tip of the soldering iron should not touch the reflector case to avoid heat-damage.
- Maintain the pre-heat and peak temperatures with dip units as low as possible and the times as short as is feasible, since the products are susceptible to heat during flow soldering.
- After soldering, allow at least three minutes for the component to cool to room temperature before further operations.
- If components will undergo multiple soldering processes, or other processes where the components may be subjected to intense heat, please check with TOPLITE for compatibility.