

SPECIFICATIONS

Seven segment Display **数码管产品规格书**

TOPLITE



MODEL: TOP-CC-12101AS

上海鼎晖科技股份有限公司
SHANGHAI TOPLITE TECHNOLOGY CO.,LTD.

www.ledtoplight.com.cn
www.ledtoplite.com



TECHNICAL DATA SHEET

TOP-CC-12101AS FOR 1.2 inch (30.6mm) digit height

1 / 6

1. PRODUCT INTRODUCTION

- ※ Low power requirement,
- ※ Solid state reliability.
- ※ Wide viewing angle.
- ※ Easy mounting on P.C. boards.
- ※ RHOS compliant.

2. FEATURES

- ※ TOP-CC-12101AS is a 1.2 inch (30.6mm) digit height
- ※ This device is made with white dots and black surface.

3. APPLICATION

- ※ Digital readout display.
- ※ Instrument panels.
- ※ Elevator.

| PART NO. | SIZE | CHIP EMITTED COLOR | FACE COLOR |
|---------------------|---------------------------------|--------------------|------------|
| TOPLIGHT-CC-12101AS | 1.2 inch (30.6mm) digit height. | Super Red | Black |

TECHNICAL DATA SHEET

TOP-CC-12101AS FOR 1.2 inch (30.6mm) digit height

4. PACKAGE DIMENSIONS & CIRCUIT DIAGRAM

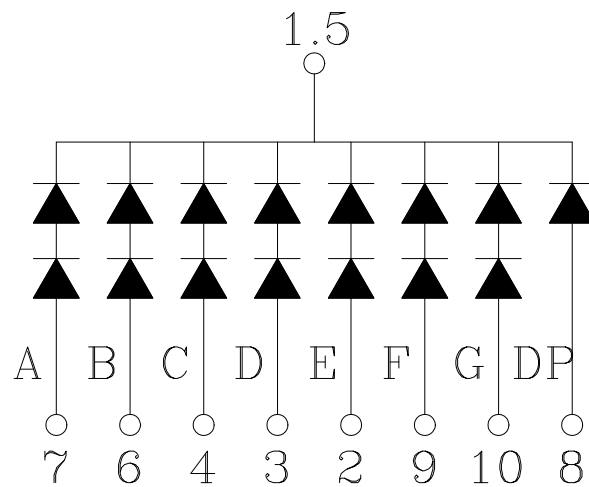
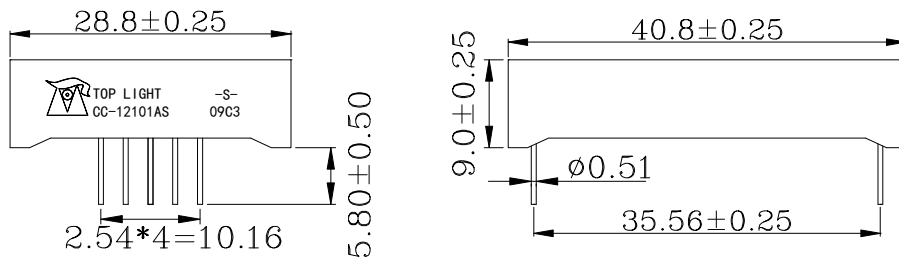
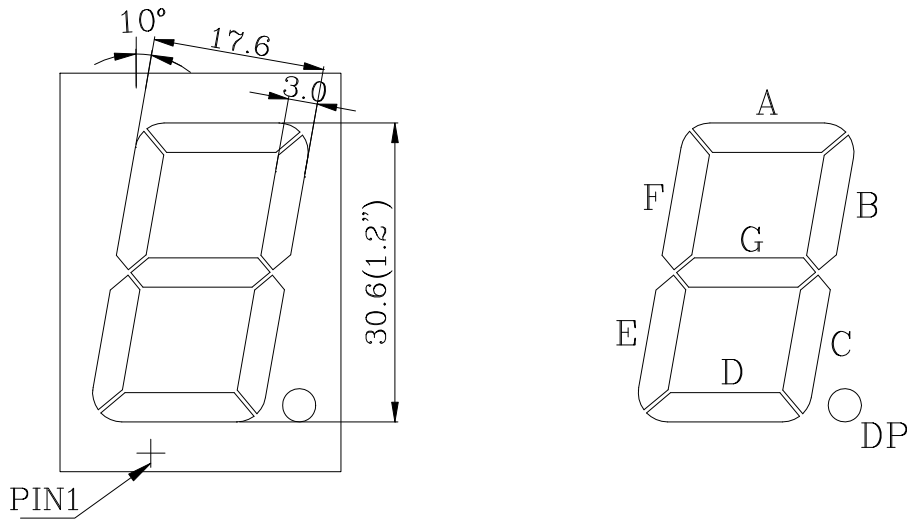



TECHNICAL DATA SHEET

TOP-CC-12101AS FOR 1.2 inch (30.6mm) digit height

3 / 6

5. ELECTRICAL/OPTICAL CHARACTERISTIC

5-1. ABSOLUTE MAXIMUM RATINGS (Ta=25°C)

| PARAMETER | SYMBOL | VALUE | UNIT |
|--|------------|-------------|--------|
| Reverse Voltage | V_R | 5 | V/seg |
| Forward Current | I_F | 30 | mA/seg |
| Peak Forward Current (1/10 Duty Cycle) | I_{PEAK} | 120 | mA/seg |
| Power Dissipation | P_D | 80 | mW/seg |
| Operating Temperature Range | T_A | - 25 ~ + 85 | °C |
| Storage Temperature Range | T_{STG} | - 30 ~ + 85 | °C |
| Solder Temperature | T_{sol} | 260/3 | °C/s |

5-2. ELECTRICAL-OPTICAL CHARACTERISTICS (Ta=25°C)

| PARAMETER | SYMBOL | MIN. | TYP. | MAX. | UNIT | TEST CONDITIONS | |
|--------------------------|------------------|------|-------|-------|-------|-----------------|------------|
| Luminous Intensity | I_V | R | 13500 | 15524 | 17549 | ucd | $I_F=10mA$ |
| | | S | 17550 | 21937 | 26325 | | |
| | | T | 26326 | 32907 | 39489 | | |
| Forward Voltage | V_F | 1.80 | 2.10 | 2.40 | v/seg | $I_F=20mA$ | |
| Chromatographer | λ_p | - | 635 | - | nm | $I_F=20mA$ | |
| Spectral Line Half-Width | $\Delta \lambda$ | - | 20 | - | nm | $I_F=20mA$ | |
| Reverse Current | I_R | - | - | 20 | uA | $V_R=5v$ | |



TECHNICAL DATA SHEET

TOP-CC-12101AS FOR 1.2 inch (30.6mm) digit height

5-3. OPTICAL CHARACTERISTIC CURVES

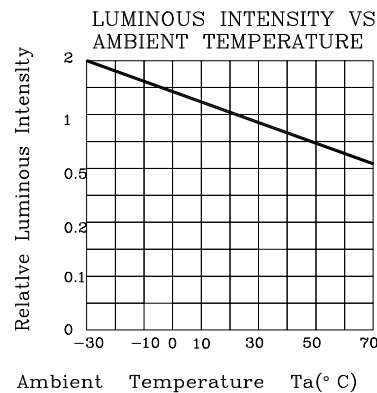
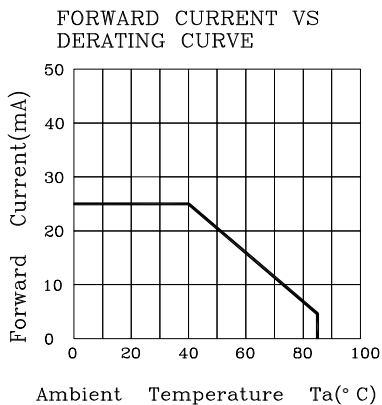
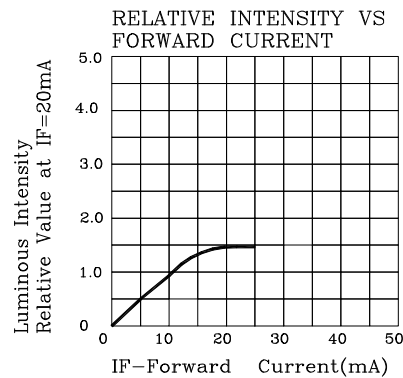
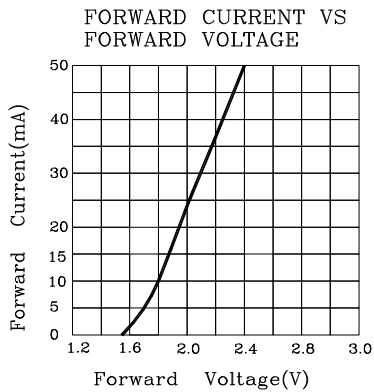
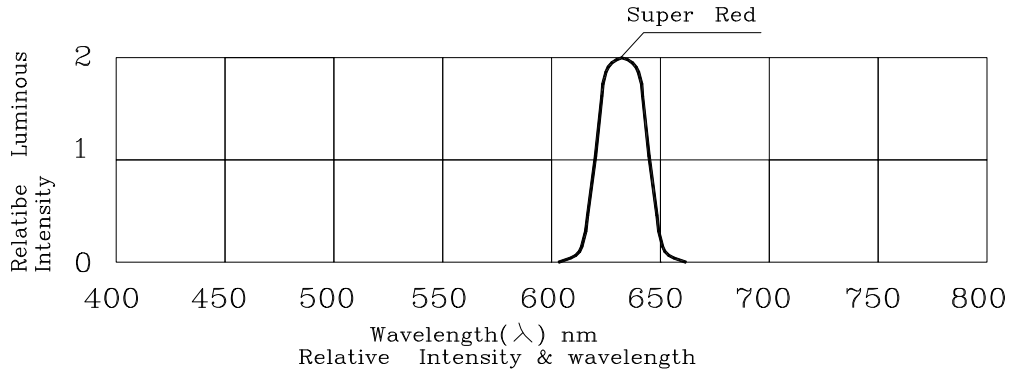



TECHNICAL DATA SHEET

TOP-CC-12101AS FOR 1.2 inch (30.6mm) digit height

5 / 6

6. QUALITY CONTROL AND ASSURANCE

| CLASSIFICATION | TEST ITEM | TEST CONDITION |
|--------------------|---|---|
| ENDURANCE TEST | OPERATION LIFE | Ta=under room temperature If=12mA-25mA per segment or Ip=80mA/duty=1/8,Pw=1.25mS Ip=160mA/duty=1/16,Pw=1.mS(DOT) Test time=1000HRS(-24HRS+72HRS) |
| | MOISTURE | Ta=65°C±5°C RH=90-95% Test time=240HRS±2HRS |
| | HIGH TEMPERATURE HIGH HUMIDITY REVERSE BIAS | Ta=65°C±5°C RH=90-95% VR=5V Test time=500hrs(-24HRS+48HRS) |
| | HIGH TEMPERATURE STORAGE | To evaluate device's durability for long term storage in high temperature Ta=85°C±5°C Test time=1000HRS(-24HRS+72HRS) |
| | LOW TEMPERATURE STORAGE | Ta=-35°C±5°C Test time=1000HRS(-24HRS+72HRS) |
| ENVIRONMENTAL TEST | TEMPERATURE CYCLING | Ta=85°C~25°C~-35°C time=30min 5min 30min 5min Cycle test:10cycles |
| | THERMAL SHOCK | Ta=85°C±5°C~-35°C±5°C time=10min 10min Cycle test:10cycles |
| | SOLOER RESISTANCE | T.sol=260°C±5°C time=10±1sec |
| | SOLOER ABILITY | T.sol=230°C±5°C time=5±1sec |

TECHNICAL DATA SHEET

TOP-CC-12101AS FOR 1.2 inch (30.6mm) digit height

6 / 6

7. SOLDERING CONDITIONS

The recommended conditions for soldering are as follows.

Because the component is made with epoxy resin, the units are susceptible to heat. Therefore, the preheating and soldering temperatures should be kept as low as possible to avoid damage.

7-1. Manual Soldering Conditions(with 1.5mm Iron tip).

Iron Tip Temperature: 350°C Max, Time: 3s Max.

Position: The iron should be situated at least 2mm away from the root of the leads.

7-2. Through the Wave Soldering Conditions Wave Soldering Profile For Lead-free Through-hole LED.

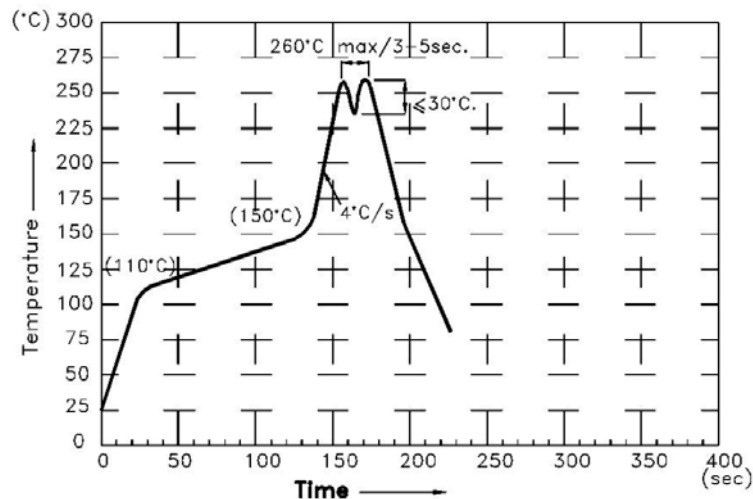

7-3. Soldering General Notes:

- Recommend manual soldering to be used only for repair and rework purposes. The soldering iron should not exceed 30W in power. The tip of the soldering iron should not touch the reflector case to avoid heat-damage.
- Maintain the pre-heat and peak temperatures with dip units as low as possible and the times as short as is feasible, since the products are susceptible to heat during flow soldering.
- After soldering, least three minutes for the component to cool to room temperature before further operations.
- If components will undergo multiple soldering processes, or other processes where the components may be subjected to intense heat, please check with toplight for compatibility.