

SPECIFICATIONS

Seven segment Display **数码管产品规格书**

TOPLITE



MODEL: TOP-CC-18102AS

上海鼎晖科技股份有限公司
SHANGHAI TOPLITE TECHNOLOGY CO.,LTD.

www.ledtoplight.com.cn
www.ledtoplite.com



TECHNICAL DATA SHEET

TOP-CC-18102AS FOR 1.8 inch (45mm) digit height

1 / 6

1. PRODUCT INTRODUCTION

- ※ Low power requirement,
- ※ Solid state reliability.
- ※ Wide viewing angle.
- ※ Easy mounting on P.C. boards.
- ※ RHOS compliant.

2. FEATURES

- ※ TOP-CC-18102AS is a 1.8 inch (45mm) digit height
- ※ This device is made with white dots and black surface.

3. APPLICATION

- ※ Digital readout display.
- ※ Instrument panels.
- ※ Elevator.

PART NO.	SIZE	CHIP EMITTED COLOR	FACE COLOR
TOPLIGHT-CC-18102AS	1.8 inch (45mm) digit height.	Super Red	Black



TECHNICAL DATA SHEET

TOP-CC-18102AS FOR 1.8 inch (45mm) digit height

4. PACKAGEDIMENSIONS&CIRCUITDIAGRAM

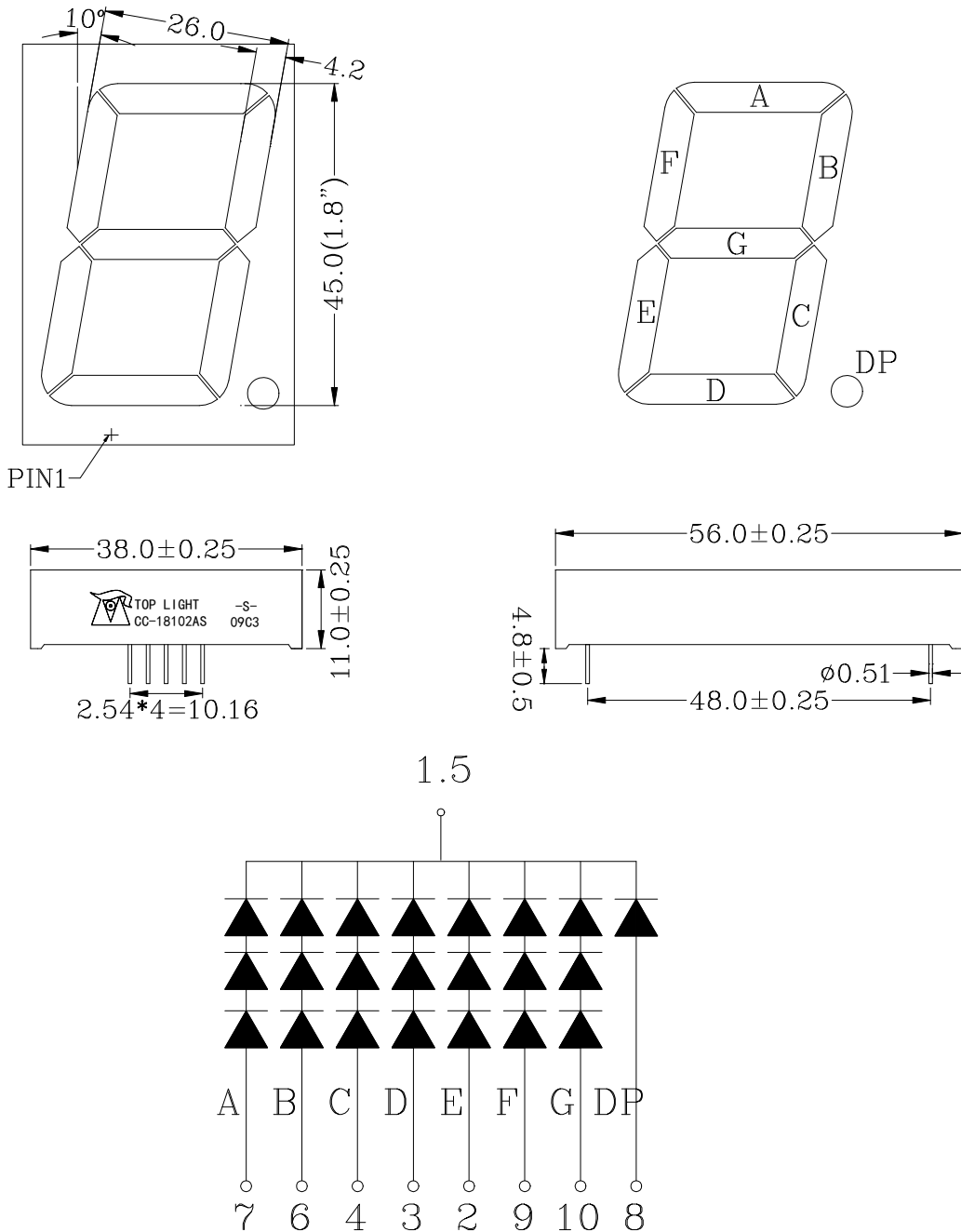



TECHNICAL DATA SHEET

TOP-CC-18102AS FOR 1.8 inch (45mm) digit height

5. ELECTRICAL/OPTICAL CHARACTERISTIC

5-1. ABSOLUTE MAXIMUM RATINGS (Ta=25°C)

PARAMETER	SYMBOL	VALUE	UNIT
Reverse Voltage	V_R	5	V/seg
Forward Current	I_F	30	mA/seg
Peak Forward Current (1/10 Duty Cycle)	I_{PEAK}	120	mA/seg
Power Dissipation	P_D	80	mW/seg
Operating Temperature Range	T_A	- 25 ~ + 85	°C
Storage Temperature Range	T_{STG}	- 30 ~ + 85	°C
Solder Temperature	T_{sol}	260/3	°C/s

5-2. ELECTRICAL-OPTICAL CHARACTERISTICS (Ta=25°C)

PARAMETER	SYMBOL	MIN.	TYP.	MAX.	UNIT	TEST CONDITIONS	
Luminous Intensity	I_V	R	13500	15524	17549	ucd	$I_F=10mA$
		S	17550	21937	26325		
		T	26326	32907	39489		
Forward Voltage	V_F	1.80	2.10	2.40	v/seg	$I_F=20mA$	
Chromatographer	λ_p	-	635	-	nm	$I_F=20mA$	
Spectral Line Half-Width	$\Delta \lambda$	-	20	-	nm	$I_F=20mA$	
Reverse Current	I_R	-	-	20	uA	$V_R=5v$	



TECHNICAL DATA SHEET

TOP-CC-18102AS FOR 1.8 inch (45mm) digit height

5-3. OPTICAL CHARACTERISTIC CURVES

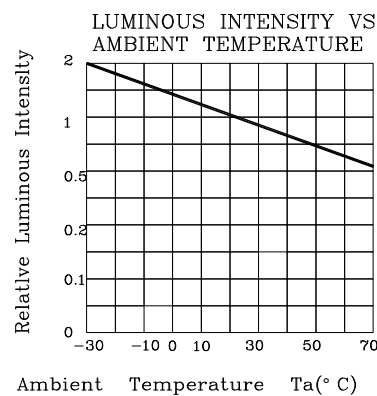
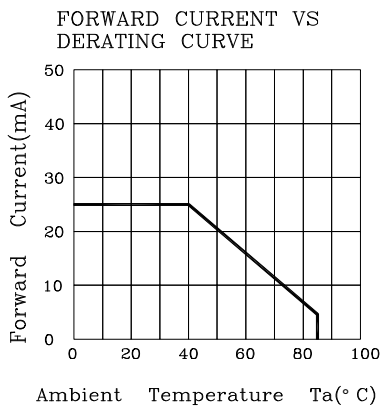
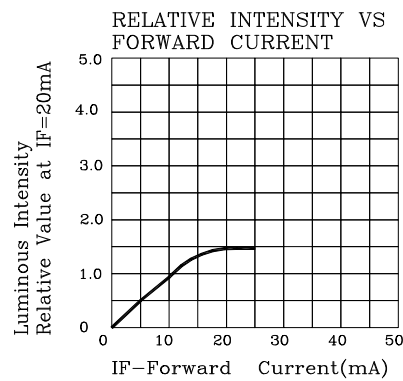
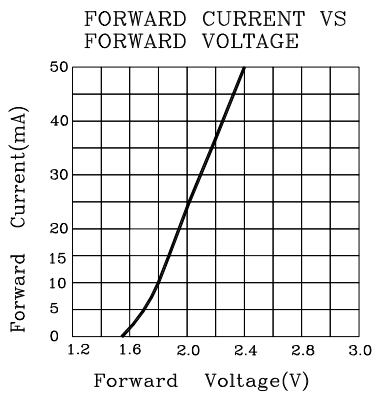
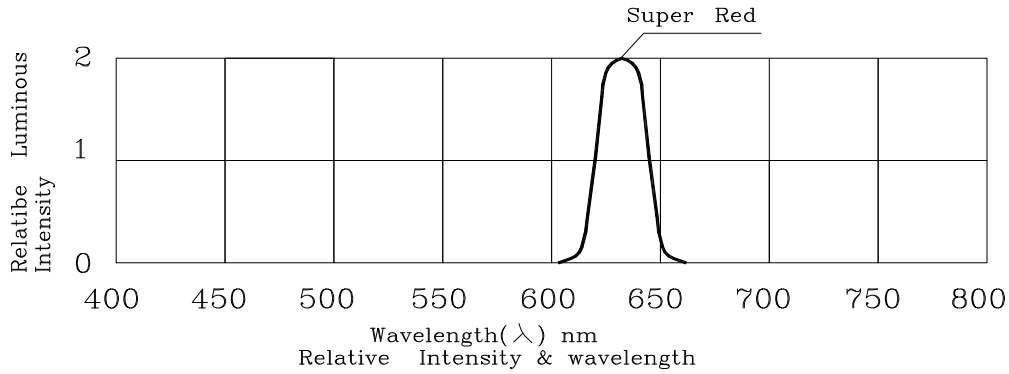



TECHNICAL DATA SHEET

TOP-CC-18102AS FOR 1.8 inch (45mm) digit height

5 / 6

6. QUALITY CONTROL AND ASSURANCE

CLASSIFICATION	TEST ITEM	TEST CONDITION
ENDURANCE TEST	OPERATION LIFE	Ta=under room temperature If=12mA-25mA per segment or Ip=80mA/duty=1/8,Pw=1.25mS Ip=160mA/duty=1/16,Pw=1.mS(DOT) Test time=1000HRS(-24HRS+72HRS)
	MOISTURE	Ta=65°C±5°C RH=90-95% Test time=240HRS±2HRS
	HIGH TEMPERATURE HIGH HUMIDITY REVERSE BIAS	Ta=65°C±5°C RH=90-95% VR=5V Test time=500hrs(-24HRS+48HRS)
	HIGH TEMPERATURE STORAGE	To evaluate device's durability for long term storage in high temperature Ta=85°C±5°C Test time=1000HRS(-24HRS+72HRS)
	LOW TEMPERATURE STORAGE	Ta=-35°C±5°C Test time=1000HRS(-24HRS+72HRS)
ENVIRONMENTAL TEST	TEMPERATURE CYCLING	Ta=85°C~25°C~-35°C time=30min 5min 30min 5min Cycle test:10cycles
	THERMAL SHOCK	Ta=85°C±5°C~-35°C±5°C time=10min 10min Cycle test:10cycles
	SOLOER RESISTANCE	T.sol=260°C±5°C time=10±1sec
	SOLOER ABILITY	T.sol=230°C±5°C time=5±1sec

TECHNICAL DATA SHEET

TOP-CC-18102AS FOR 1.8 inch (45mm) digit height

6 / 6

7. SOLDERING CONDITIONS

The recommended conditions for soldering are as follows.

Because the component is made with epoxy resin, the units are susceptible to heat. Therefore, the preheating and soldering temperatures should be kept as low as possible to avoid damage.

7-1. Manual Soldering Conditions(with 1.5mm Iron tip).

Iron Tip Temperature: 350°C Max, Time: 3s Max.

Position: The iron should be situated at least 2mm away from the root of the leads.

7-2. Through the Wave Soldering Conditions Wave Soldering Profile For Lead-free Through-hole LED.

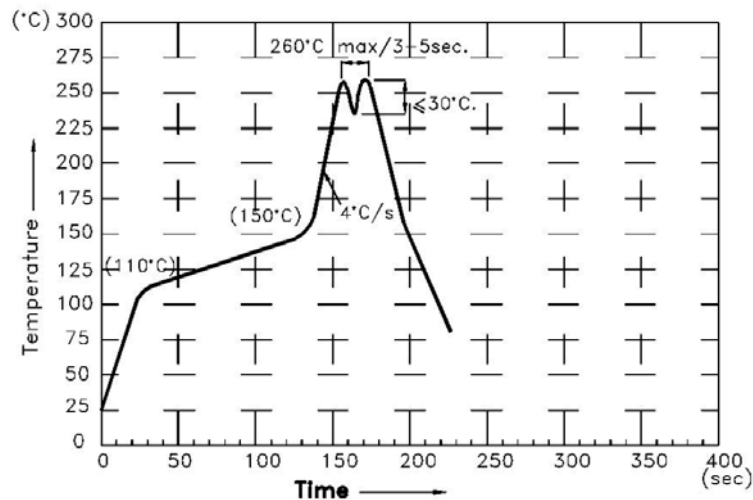

7-3. Soldering General Notes:

- Recommend manual soldering to be used only for repair and rework purposes. The soldering iron should not exceed 30W in power. The tip of the soldering iron should not touch the reflector case to avoid heat-damage.
- Maintain the pre-heat and peak temperatures with dip units as low as possible and the times as short as is feasible, since the products are susceptible to heat during flow soldering.
- After soldering, least three minutes for the component to cool to room temperature before further operations.
- If components will undergo multiple soldering processes, or other processes where the components may be subjected to intense heat, please check with toplight for compatibility.