

# SPECIFICATIONS

---

LED Lamps **发光二极管产品规格书**

# TOPLITE



**MODEL: TOP-244HGD-611**

---

**上海鼎晖科技股份有限公司**

SHANGHAI TOPLITE TECHNOLOGY CO.,LTD.

[www.ledtoplight.com.cn](http://www.ledtoplight.com.cn)  
[www.ledtoplite.com](http://www.ledtoplite.com)



## TECHNICAL DATA SHEET

### TOP-244HGD-611 <FOR 4.1MM×2.1MM RECTANGULAR LED LAMP>

1 / 6

#### 1. FEATURES

- ※ Rectangular legend.
- ※ Low power requirement,
- ※ High reliability and a broad range of colors and packages.
- ※ Pb free.
- ※ RoHS compliant.

#### 2. DESCRIPTION

- ※ These devices are designed from advanced optical grade epoxy, which provide superior high temperature performance and excellent moisture resistance.
- ※ The LED lamps are available with different colors, intensities.

#### 3. APPLICATION

- ※ Indicator.
- ※ TV set.
- ※ Auto.
- ※ Monitor

PART NO.	SIZE	CHIP EMITTED COLOR	FACE COLOR
TOP-244HGD-611	4.1mm×2.1mm rectangular	Yellow Green	Green Diffused

## TECHNICAL DATA SHEET

TOP-244HGD-611 <FOR 4.1MM×2.1MM RECTANGULAR LED LAMP>

2 / 6

### 4. PACKAGE DIMENSIONS & CIRCUIT DIAGRAM

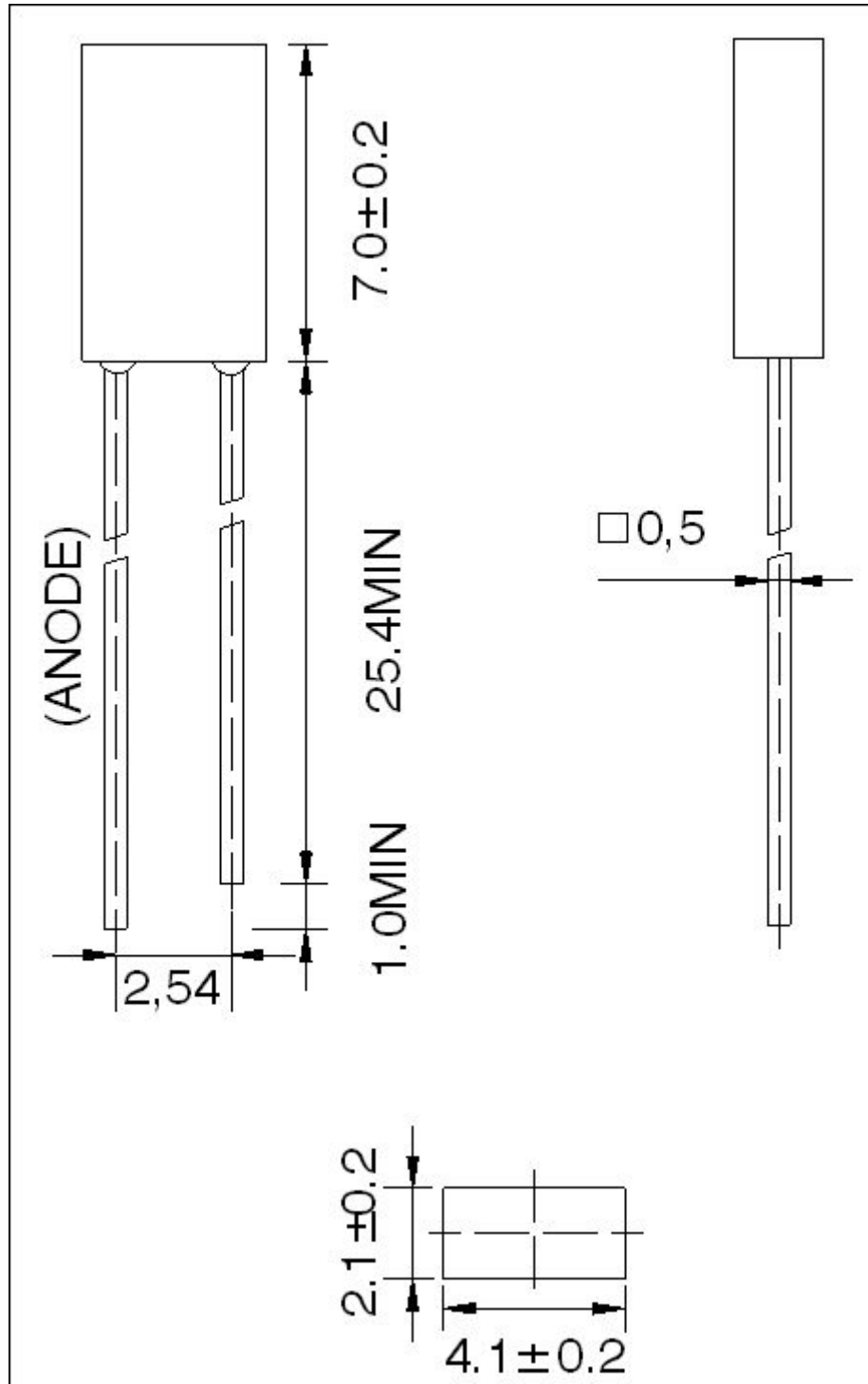

**TECHNICAL DATA SHEET****TOP-244HGD-611** <FOR 4.1MM×2.1MM RECTANGULAR LED LAMP>

3 / 6

**5. ELECTRICAL/OPTICAL CHARACTERISTIC****5-1. ABSOLUTE MAXIMUM RATINGS (Ta=25°C)**

PARAMETER PER SEGMENT	SYMBOL	MAX	UNIT
Reverse Voltage	V <sub>R</sub>	5	V
Forward Current	I <sub>F</sub>	30	mA
Peak Forward Current (1/10 Duty Cycle)	I <sub>PEAK</sub>	150	mA
Power Dissipation	P <sub>D</sub>	80	mW
Operating Temperature Range	T <sub>A</sub>	- 40 ~ + 85	°C
Storage Temperature Range	T <sub>STG</sub>	- 40 ~ + 85	°C
Solder Temperature 1/16 inch below seating plane for 3 seconds MAX 260°C			

**5-2. ELECTRICAL/OPTICAL CHARACTERISTICS (Ta=25°C)**

PARAMETER	SYMBOL	MIN.	TYP.	MAX.	UNIT	TEST CONDITIONS	
Luminous Intensity	I <sub>v</sub>	L1	5	-	19	mcd	I <sub>F</sub> =20mA
		L2	20	-	29		
		L3	30	-	39		
Forward Voltage	V <sub>F</sub>	1.80	2.10	2.50	v	I <sub>F</sub> =20mA	
Viewpoint	2θ <sub>1/2</sub>	-	-	-	deg	I <sub>F</sub> =20mA	
Peak Emission Wavelength	λ <sub>p</sub>	-	570	-	nm	I <sub>F</sub> =20mA	
Spectral Line Half-Width	Δλ	-	20	-	nm	I <sub>F</sub> =20mA	
Reverse Current	I <sub>R</sub>	-	-	10	uA	V <sub>R</sub> =5v	

TECHNICAL DATA SHEET

TOP-244HGD-611 <FOR 4.1MM×2.1MM RECTANGULAR LED LAMP>

5-3. ELECTRICAL/OPTICAL CHARACTERISTIC CURVES

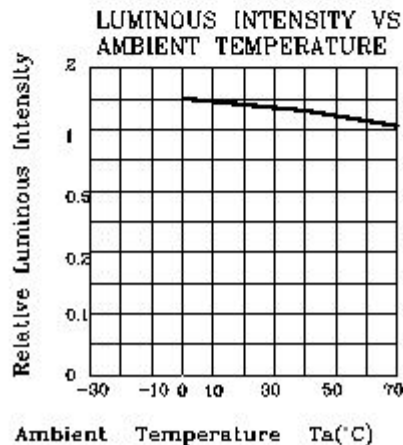
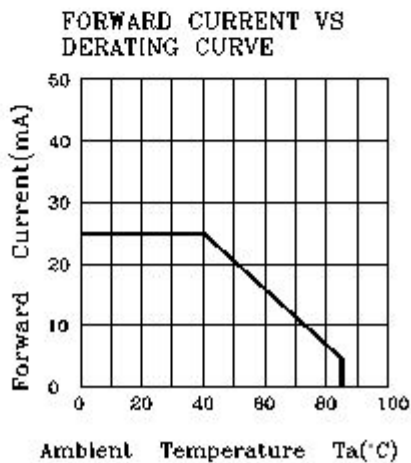
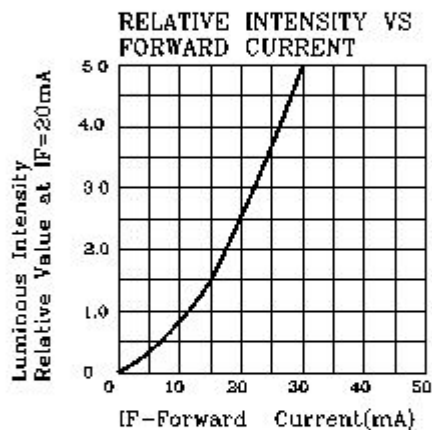
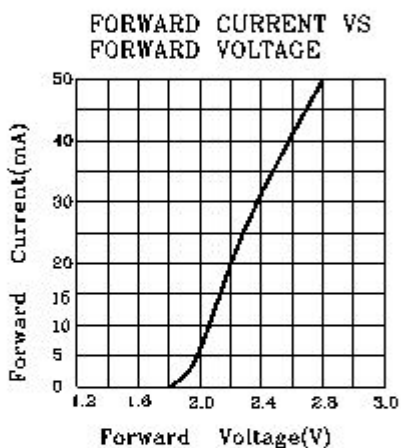
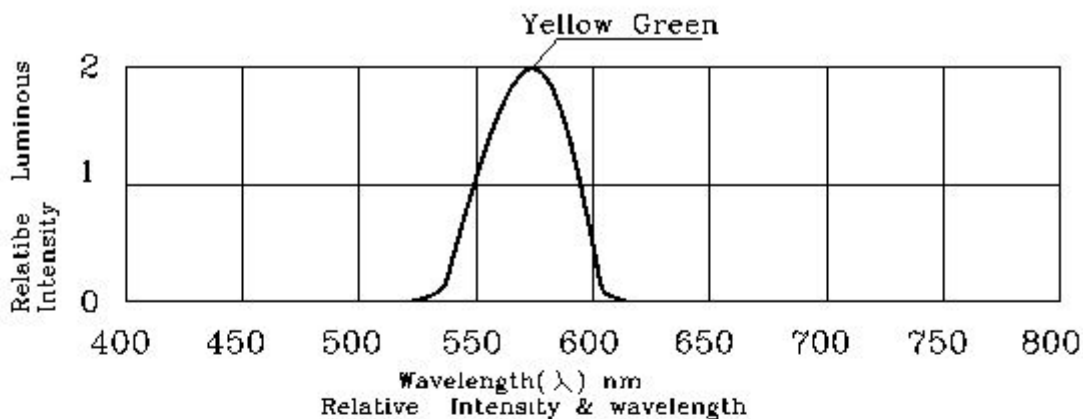



## TECHNICAL DATA SHEET

### TOP-244HGD-611 <FOR 4.1MM×2.1MM RECTANGULAR LED LAMP>

5 / 6

## 6. QUALITY CONTROL AND ASSURANCE

CLASSIFICATION	TEST ITEM	TEST CONDITION
ENDURANCE TEST	OPERATION LIFE	Ta=under room temperature If=12mA-25mA per segment or Ip=80mA/duty=1/8,Pw=1.25mS Ip=160mA/duty=1/16,Pw=1.mS(DOT) Test time=1000HRS(-24HRS+72HRS)
	MOISTURE	Ta=65°C±5°C RH=90-95% Test time=240HRS±2HRS
	HIGH TEMPERATURE HIGH HUMIDITY REVERSE BIAS	Ta=65°C±5°C RH=90-95% VR=5V Test time=500hrs(-24HRS+48HRS)
	HIGH TEMPERATURE STORAGE	To evaluate device's durability for long term storage in high temperature Ta=85°C±5°C Test time=1000HRS(-24HRS+72HRS)
	LOW TEMPERATURE STORAGE	Ta=-35°C±5°C Test time=1000HRS(-24HRS+72HRS)
ENVIRONMENTAL TEST	TEMPERATURE CYCLING	Ta=85°C~25°C~-35°C time=30min 5min 30min 5min Cycle test:10cycles
	THERMAL SHOCK	Ta=85°C±5°C~-35°C±5°C time=10min 10min Cycle test:10cycles
	SOLOER RESISTANCE	T.sol=260°C±5°C time=10±1sec
	SOLOER ABILITY	T.sol=230°C±5°C time=5±1sec

## TECHNICAL DATA SHEET

**TOP-244HGD-611** <FOR 4.1MM×2.1MM RECTANGULAR LED LAMP>

6 / 6

### 7. SOLDERING CONDITIONS

The recommended conditions for soldering are as follows.

Because the component is made with epoxy resin, the units are susceptible to heat. Therefore, the preheating and soldering temperatures should be kept as low as possible to avoid damage.

**7-1. Manual Soldering Conditions(with 1.5mm Iron tip ).**

Iron Tip Temperature: 350°C Max, Time: 3s Max.

Position: The iron should be situated at least 2mm away from the root of the leads.

**7-2. Through the Wave Soldering Conditions Wave Soldering Profile For Lead-free Through-hole LED.**

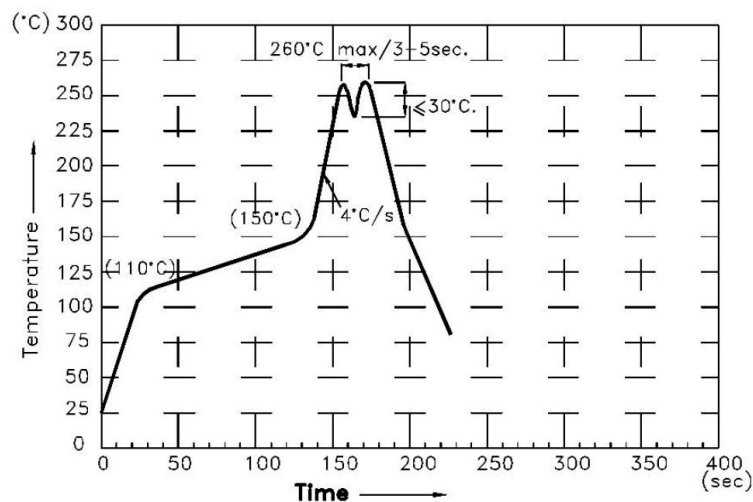

**7-3. Soldering General Notes:**

- Recommend manual soldering to be used only for repair and rework purposes. The soldering iron should not exceed 30W in power. The tip of the soldering iron should not touch the reflector case to avoid heat-damage.
- Maintain the pre-heat and peak temperatures with dip units as low as possible and the times as short as is feasible, since the products are susceptible to heat during flow soldering.
- After soldering, least three minutes for the component to cool to room temperature before further operations.
- If components will undergo multiple soldering processes, or other processes where the components may be subjected to intense heat, please check with toplight for compatibility.