

SPECIFICATIONS

Backlight **背光源产品规格书**

TOPLITE



MODEL: TBL-58130UW6

上海鼎晖科技股份有限公司

SHANGHAI TOPLITE TECHNOLOGY CO.,LTD.

www.ledtoplight.com.cn

www.ledtoplite.com



TECHNICAL DATA SHEET

TBL-58130UW6

1. FEATURES

- ※ 57.5*119.3mm is emitting surface size of backlight
- ※ Low power requirement, solid state reliability.
- ※ Multicolor available, stackable horizontally.
- ※ Categorized for luminous intensity.
- ※ Easy mounting on P.C. boards.
- ※ Remain within RoHS compliant version.

2. DESCRIPTION

- ※ The TBL-58130UW6 is a 57.5*119.3mm emitting surface backlight.

3. APPLICATION

- ※ General lighting solutions
- ※ LCD display backlight

PART NO.	SIZE	CHIP EMITTED COLOR
TBL-58130UW6	57.5*119.3mm	White

TECHNICAL DATA SHEET
TBL-58130UW6

4. PACKAGE DIMENSIONS & CIRCUIT DIAGRAM

PACKAGE DIMENSIONS

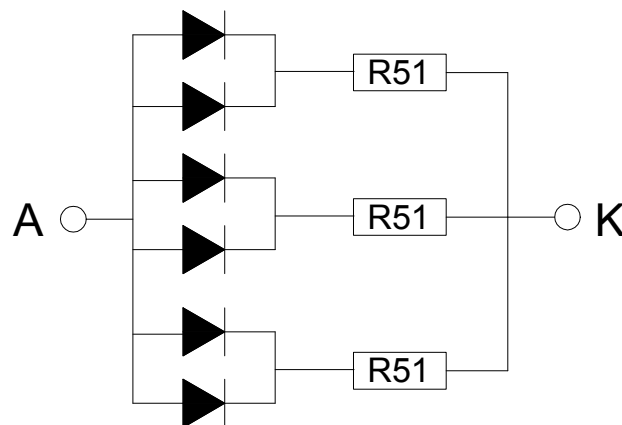
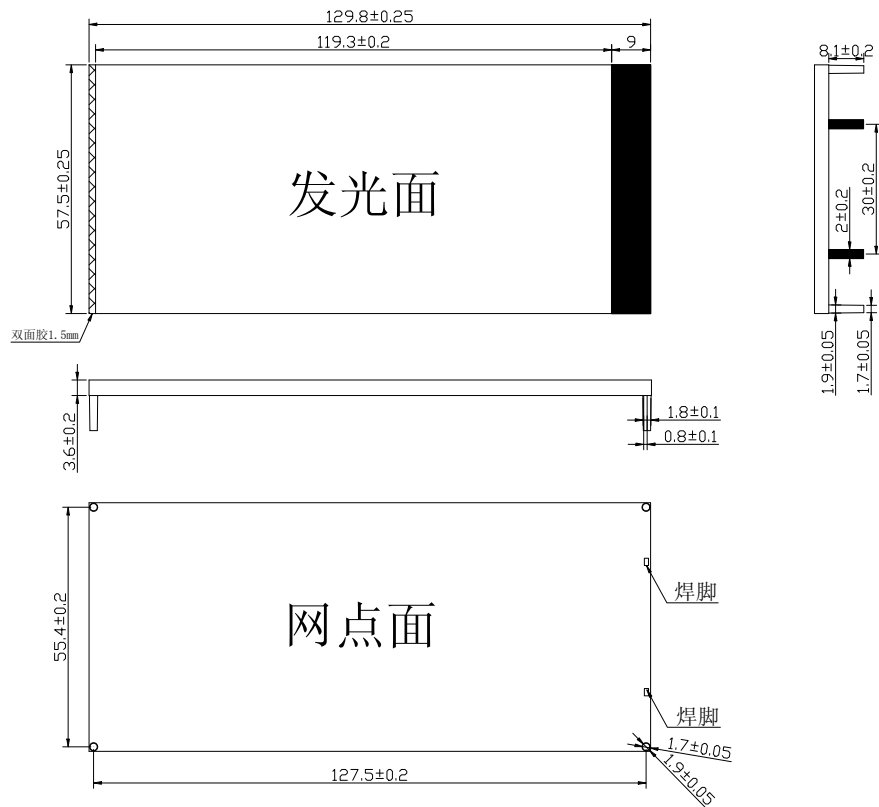

**TECHNICAL DATA SHEET**
TBL-58130UW6

3 / 6

5. ELECTRICAL/OPTICAL CHARACTERISTIC**5-1. ABSOLUTE MAXIMUM RATINGS (Ta=25°C)**

PARAMETER	SYMBOL	VALUE	UNIT
Reverse Voltage	V _R	5	V
Peak Forward Current (1/10 Duty Cycle)	I _{PEAK}	120	mA
Power Dissipation	P _D	450	mW
Operating Temperature Range	T _A	- 35 ~ + 85	°C
Storage Temperature Range	T _{STG}	- 35 ~ + 85	°C

5-2. ELECTRICAL/OPTICAL CHARACTERISTICS (Ta=25°C)

PARAMETER	SYMBOL	MIN.	TYP.	MAX.	UNIT
Forward Current	I _f	-	90	-	mA
Forward Voltage	V _f	-	5	-	V
Peak Emission Wavelength	λ _p	-	-	-	nm
Spectral Line Half-Width	Δλ	-	30	-	nm
Color temperature	TC	20000	-	25000	K
Luminous Uniformity	-	-	75%	-	-
Brightness	-	400	-	700	cd/m
Discreteness	-	-	25%	-	-

TECHNICAL DATA SHEET

TBL-58130UW6

5-3. ELECTRICAL/OPTICAL CHARACTERISTIC CURVES

ELECTRICAL/OPTICAL CHARACTERISTIC (2)

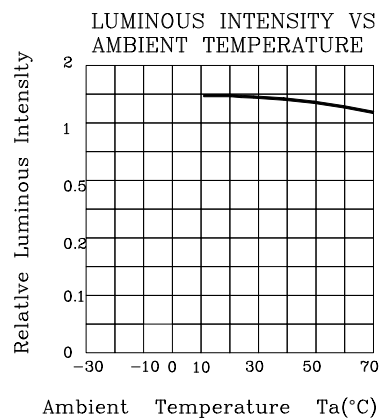
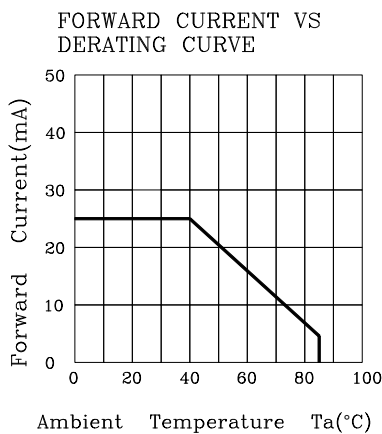
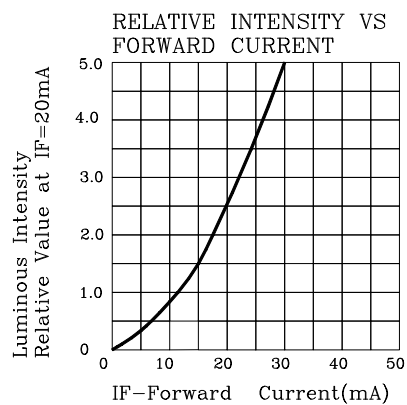
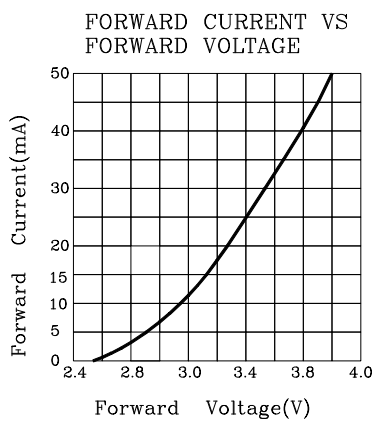
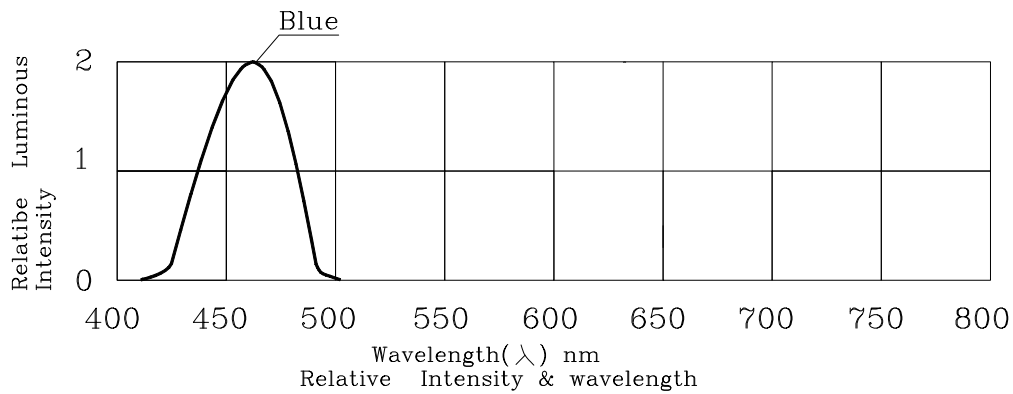



TECHNICAL DATA SHEET
TBL-58130UW6

6. QUALITY CONTROL AND ASSURANCE

CLASSIFICATION	TEST ITEM	TEST CONDITION
ENDURANCE TEST	OPERATION LIFE	Ta=under room temperature If=12mA-25mA per segment or Ip=80mA/duty=1/8,Pw=1.25mS Ip=160mA/duty=1/16,Pw=1.mS(DOT) Test time=1000HRS(-24HRS+72HRS)
	MOISTURE	Ta=65°C±5°C RH=90-95% Test time=240HRS±2HRS
	HIGH TEMPERATURE HIGH HUMIDITY REVERSE BIAS	Ta=65°C±5°C RH=90-95% VR=5V Test time=500hrs(-24HRS+48HRS)
	HIGH TEMPERATURE STORAGE	To evaluate device's durability for long term storage in high temperature Ta=85°C±5°C Test time=1000HRS(-24HRS+72HRS)
	LOW TEMPERATURE STORAGE	Ta=-35°C±5°C Test time=1000HRS(-24HRS+72HRS)
ENVIRONMENTAL TEST	TEMPERATURE CYCLING	Ta=85°C~25°C~-35°C time=30min 5min 30min 5min Cycle test:10cycles
	THERMAL SHOCK	Ta=85°C±5°C~-35°C±5°C time=10min 10min Cycle test:10cycles
	SOLOER RESISTANCE	T.sol=260°C±5°C time=10±1sec
	SOLOER ABILITY	T.sol=230°C±5°C time=5±1sec

TECHNICAL DATA SHEET

TBL-58130UW6

6 / 6

7. SOLDERING CONDITIONS

The recommended conditions for soldering are as follows.

Because the component is made with epoxy resin, the units are susceptible to heat. Therefore, the preheating and soldering temperatures should be kept as low as possible to avoid damage.

7-1. Manual Soldering Conditions(with 1.5mm Iron tip).

Iron Tip Temperature: 350°C Max, Time: 3s Max.

Position: The iron should be situated at least 2mm away from the root of the leads.

7-2. Through the Wave Soldering Conditions Wave Soldering Profile For Lead-free Through-hole LED.

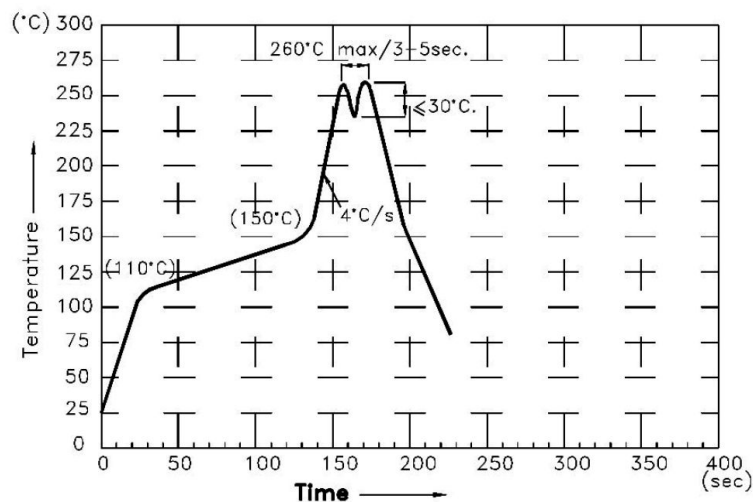

7-3. Soldering General Notes:

- Recommend manual soldering to be used only for repair and rework purposes. The soldering iron should not exceed 30W in power. The tip of the soldering iron should not touch the reflector case to avoid heat-damage.
- Maintain the pre-heat and peak temperatures with dip units as low as possible and the times as short as is feasible, since the products are susceptible to heat during flow soldering.
- After soldering, least three minutes for the component to cool to room temperature before further operations.
- If components will undergo multiple soldering processes, or other processes where the components may be subjected to intense heat, please check with for compatibility.